

WallVIEW™ PTZ Systems

WallVIEW 50i PTZ, WallVIEW 100 PTZ and WallVIEW 70 PTZ Pan/Tilt/Zoom Camera Systems



Figure 1: WallVIEW Systems (left to right); WallVIEW 50i PTZ, WallVIEW 100 PTZ, WallVIEW 70 PTZ, with each camera showing EZCamera Cabling Shoe and Thin Profile wall mount bracket.

INTRODUCTION

The Vaddio WallVIEW PTZ Camera Systems are complete wall-mounted camera packages featuring the Vaddio EZCamera™ Cabling System that allows the installer to use Category 5 cabling to run power, video and camera control. The included PowerRite™ power supply provides the right amount of power required for proper operation of the camera over Cat. 5 cabling.

INTENDED USE

Before installing the Vaddio WallVIEW PTZ Camera Systems, please read the entire manual thoroughly. All Vaddio camera systems were designed for use indoors. Outdoor operation is not recommended, hasn't been tested, and could damage the camera and/or create a potentially unsafe operating condition. Use only the Vaddio PowerRite power supply provided.

IMPORTANT SAFEGUARDS

Read and understand all instructions before using. Do not operate any electrical device if it has been dropped or damaged. In this case, a Vaddio technician must examine the product before operating. To reduce the risk of electric shock, do not immerse in water or other liquids and avoid extremely humid conditions.



**Use only the power supply provided with the Vaddio WallVIEW products.
Use of any unauthorized power supply will void any and all warranties.**



UNPACKING

Carefully remove all of the parts from the packaging. Unpack and identify the following parts for each of the WallVIEW systems:

WallVIEW 100 PTZ

Part Numbers: 999-2204-000 (NTSC) and 999-2204-001 (PAL)

- One (1) Sony® EVI-D100 Camera (not included in WallVIEW Kit)
- Vaddio IR Remote Commander for Sony Cameras (not included in Kit version)
- One (1) Vaddio EZCamera Cable Shoe for D100 camera
- One (1) Thin Profile wall mount bracket (matching color)
- One (1) 12' (3.66m) S-Video cable
- One (1) 12' (3.66m) Composite video cable (RCA connectors)
- One (1) Vaddio Quick-Connect™ Box
- One (1) EZCamera Control Adapter
- One (1) 15VDC PowerRite power supply with power cable
For PAL camera versions, both EURO and UK Power cables are included.
- Mounting hardware & Documentation

WallVIEW 70 PTZ

Part Numbers: 999-2704-000 (NTSC) and 999-2704-001 (PAL)

- One (1) Sony EVI-D70 Camera (not included in WallVIEW Kit)
- Vaddio IR Remote Commander for Sony Cameras (not included in Kit version)
- One (1) Vaddio EZCamera Cable Shoe for D70 camera
- One (1) Thin Profile wall mount bracket (matching color)
- One (1) 12' (3.66m) S-Video cable
- One (1) 12' (3.66m) Composite video cable (RCA connectors)
- One (1) Vaddio Quick-Connect™ Box
- One (1) EZCamera Control Adapter
- One (1) 18VDC PowerRite power supply with power cable
For PAL camera versions, both EURO and UK Power cables are included.
- Mounting hardware & Documentation

WallVIEW 50i PTZ

Part Numbers: 999-4204-000 (NTSC) and 999-4204-001 (PAL)

- One (1) Canon® VC-C50i Camera with Canon IR Remote
- One (1) Vaddio EZCamera Cable Shoe for 50i Camera
- One (1) Thin Profile wall mount bracket
- One (1) 12' (3.66m) S-Video cable
- One (1) 12' (3.66m) Composite video cable (RCA connectors)
- One (1) Vaddio Quick-Connect™ Box
- One (1) EZCamera Control Adapter
- One (1) 18VDC PowerRite power supply with power cable
For PAL camera versions, both EURO and UK Power cables are included.
- Mounting hardware & Documentation

Important Note:

The table below provides minimum and maximum CAT-5 cable distances that can be used with the standard and optional power supplies with each camera system. 24 VDC power supplies are available as an accessory (Part # 451-2000-024).

	18 VDC Power Supply (included)	24 VDC Power Supply (sold separately)
WallVIEW 100	Up to 115 ft. (35.1m)	115 ft. to 250 ft. (35.1m to 76.2m)
WallVIEW 70	Up to 200 ft. (61m)	200 ft. to 300 ft. (61m to 91.4m)
WallVIEW 50	Up to 185 ft. (56.4m)	185 ft. to 275 ft. (56.4m to 83.8m)

INSTALLATION

The WallVIEW products are cameras specifically designed for installation on a vertical wall surface with Cat. 5 cable connectivity for Power, Video and Control signaling. Installation is simplified in that no custom 8-Pin mini-din cables or expensive S-Video plenum cables are needed and no power outlets are required near the camera bracket. All cabling is routed to the head-end using Cat. 5 cabling with the EZCamera Cabling system.

Before Installing

- Locate the camera mounting location paying close attention to camera viewing angles, lighting conditions, possible line of site obstructions, and checking for in-wall obstructions where the camera is to be mounted. Pick a mounting location to optimize the performance of the camera.
- Pre-wire all cabling as required (see wiring diagram examples).
- The WallVIEW 100, 70 and 50i can be mounted to standard 2-gang wall boxes. All cameras are basically lightweight and the thin profile wall mount bracket can be adequately secured to the wall with the four (4) provided conical plastic wall anchors (or your choice of dry wall anchor).

Wiring Diagram Examples

The Basic Idea: WallVIEW 50i, 70 & 100 PTZ

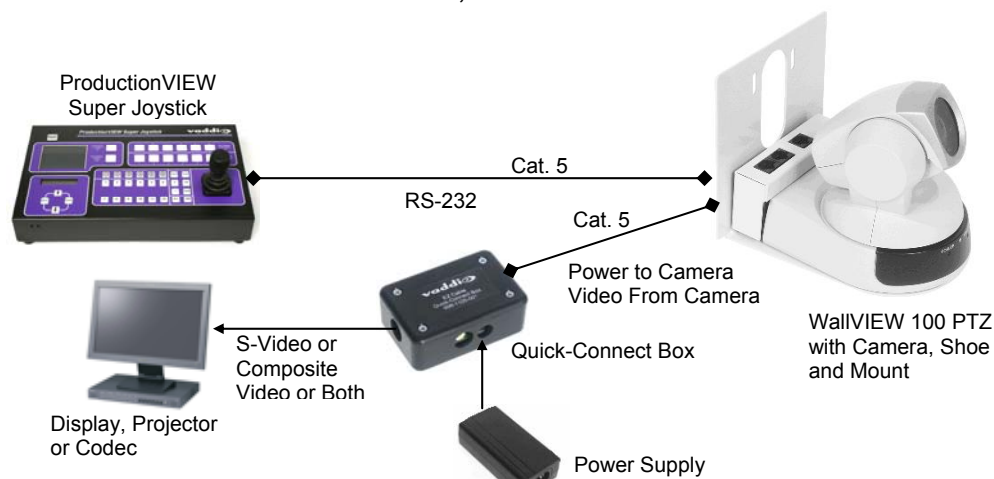
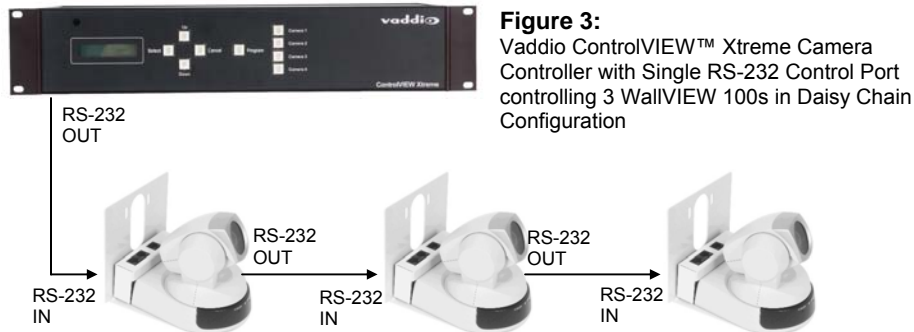

Figure 2: The WallVIEW 50i, 70 & 100 uses a single cat. 5 for Power and Video and a 2nd Cat. 5 for control. Control is wired in a daisy chain configuration if a single control port is to be used.

Daisy Chain Control Configuration



Note: TXD, RXD & GND are required for basic control. For Daisy Chaining, DSR and DTR are required for Sony products (Pins 1 and 2 on the Cat. 5 cable) and CTS and RTS are Required for Canon products (Pins 3 and 4 on the Cat. 5 cable).

MOUNTING INSTRUCTIONS

Step 1:

After determining the optimum location of the camera system, route the Cat. 5 cabling from the camera to the Quick-Connect Box located at the head-end. The cable should pass through the oval slot located on the rear flange of the wall mount (Figure 4).



Figure 4: Wall Mount bracket showing oval cabling through-hole on back of mounting flange. Mount may be mounted to the wall with conical wall anchors or to 2-gang wall box

Be sure to leave several inches of Cat. 5 extending out from the wall for ease of connection.

Step 2: If the bracket is to be mounted on a 2-gang wall box, use the screws supplied with the wall box cover plate to attach the Thin Profile wall mount bracket. If the bracket is to be mounted to the dry wall, then mark and drill 3/16" (4.76mm) holes. Make sure that the holes line up and provide a level, flat mounting surface. Tap in the four (4) provided plastic conical wall anchors and mount the wall mount to the anchors with the supplied sheet metal screws.

Step 3: Carefully attach the Vaddio EZCamera Shoe to the back connector plate of the camera. Note: Do not force, the shoe should slide into place and make positive connection with a minimum of effort.

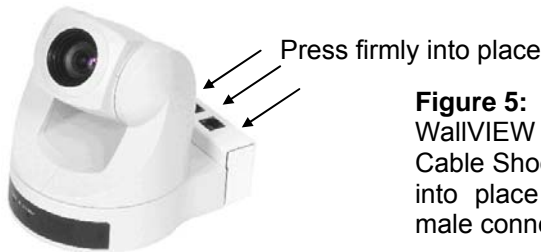

Figure 5: WallVIEW 70 shown with EZCamera Cable Shoe. Carefully slide the shoe into place taking care to seat the male connections firmly into place.

Step 4: Place the camera onto the camera mount and plug in the Cat. 5, RJ-45 connectors. Using the supplied 1/4"-20 machine screw, secure the camera to the mount through the mounting slot (see Figure 4). Gently push camera back towards the rear of the mount, feeding the excess cable into the wall or wall box, until the shoe is held up against the wall mount, then tighten bottom screw.

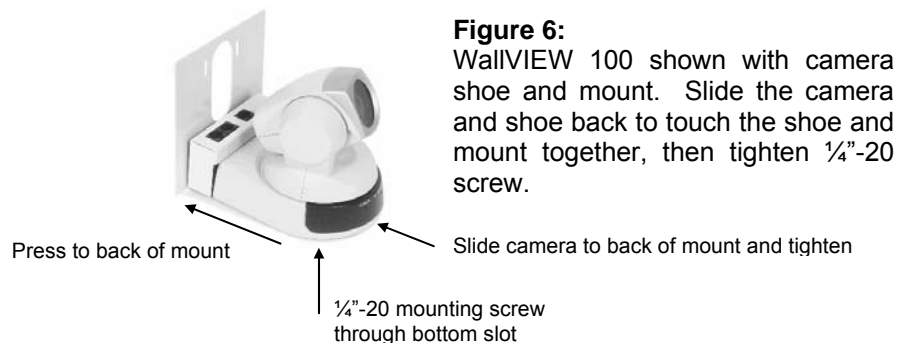

Figure 6: WallVIEW 100 shown with camera shoe and mount. Slide the camera and shoe back to touch the shoe and mount together, then tighten 1/4"-20 screw.

Step 5: Attach the Cat. 5 cable for Power and Video on the Quick-Connect Box. Use the supplied Video cables and plug these cables from the Quick-Connect Box to the video destination (codec, monitor, projector). Connect the PowerRite power supply to the Quick-Connect Box power input (see Figure 2).

Step 6: Verify all connections. Please check all Cat. 5 cables for continuity in advance to final connection. This will save hours of trouble shooting time.

Connect only the Vaddio supplied power supply to an AC outlet. Power will travel down the Cat. 5 cable to the cable shoe, powering the camera. The camera will “Home” to a centered position ready for control information from the provided Vaddio IR Remote Commander (WallVIEW 70, 100) or Canon IR Remote (WallVIEW 50i PTZ) or RS-232 Camera controller of the integrators’ choice.

Completing the Installation

To insure proper continuity of control and operation of the cameras, the RS-232 controller (control system or joystick) should be powered on after the cameras. The cameras should be powered up first in the control line. Depending on how your programs are written, and if the cameras are turned off every night, please adhere to the described power-up order to ensure proper operation.

INFORMATION

For documents on video, power and control pin-outs, please see the Vaddio website under Vaddio Technical Note #101 or the Appendix at the back of this manual.

Vaddio has prepared a number of TechNotes, specifications and drawings designed to inform and educate integrators’ of the value and the specific uses of Vaddio products.

CARE AND CLEANING

- Do not attempt to take the products in these systems apart. There are no user-serviceable components inside.
- Do not spill liquids on the products
- Keep these devices away from food and liquid
- For smears or smudges on the lens, wipe with a clean, soft cloth. Do not use any abrasive chemicals on the camera body at any time.

OPERATING AND STORAGE CONDITIONS

Do not store or operate the WallVIEW System under the following conditions for any circumstance:

- Temperatures above 40°C (104°F)
- Temperatures below 0°C (32°F)
- High humidity, condensing or wet environments
- Dusty environments
- In inclement weather
- Under severe vibration



**WARRANTY
INFORMATION**

Hardware* Warranty - One year limited warranty on all parts. Vaddio warrants this product against defects in materials and workmanship for a period of one year from the day of purchase if Vaddio receives notice of such defects during the warranty. They will, at its option, repair or replace products that prove to be defective.

Exclusions - The above warranty shall not apply to defects resulting from: improper or inadequate maintenance by the customer, customers applied software or interfacing, unauthorized modifications or misuse, operation outside the normal environmental specifications for the product, use of the incorrect power supply, or improper site operation and maintenance.

Vaddio Customer Service – Vaddio will test, repair, or replace the product or products without charge if the unit is under warranty. If the product is out of warranty, Vaddio will test then repair the product or products. The cost of parts and labor charge will be estimated by a technician and confirmed by the customer prior to repair. All components must be returned for testing as a complete unit. Vaddio will not accept responsibility for shipment after it has left the premises.

Return Material Authorization (RMA) Number - Before returning a product for repair or replacement request an RMA from Vaddio's technical support. Provide a technician with a return phone number, e-mail address, shipping address, and product serial numbers. Describe the reason for repairs or returns as well as the date of purchase. Include your assigned RMA number in all correspondence with Vaddio. Write your assigned RMA number on the outside of the box when returning the product.

Voided Warranty – The warranty does not apply if the original serial number has been removed or if the product has been disassembled or damaged through misuse, accident, modifications, or unauthorized repair.

Shipping and Handling - Vaddio will not pay for inbound shipping transportation or insurance charges or accept any responsibility for laws and ordinances from inbound transit. Vaddio will pay for outbound shipping, transportation, and insurance charges for all items under warranty but will not assume responsibility for loss and/or damage by the outbound freight carrier. If the return shipment appears damaged, retain the original boxes and packing material for inspection by the carrier. Contact your carrier immediately.

Products not Under Warranty - Payment arrangements are required before outbound shipment for all out of warranty products.

*Vaddio manufactures its hardware products from parts and components that are new or equivalent to new in accordance with industry standard practices.

Appendix 1:

Vaddio Power, Video and Control Pin-outs

For Vaddio Cameras: WallVIEW 50i PTZ, WallVIEW 70 PTZ and WallVIEW 100 PTZ

Power/Video Connection RJ-45 – Camera Shoe

#	Pins
1)	Power (+)
2)	Power GND
3)	Video GND
4)	Y (luminance)
5)	Video GND
6)	C (Chrominance)
7)	Video GND
8)	Composite Video

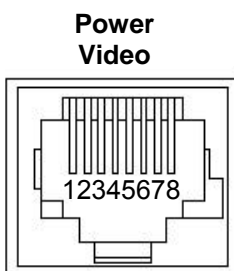

RS-232 Connector IN – Camera Shoe

#	Pins
1)	DTR (Sony® Daisy chain to DSR)
2)	DSR (Sony Daisy chain from DTR)
3)	CTS (Canon® Daisy chain to RTS)
4)	RTS (Canon Daisy chain from CTS)
5)	Unused
6)	Digital GND
7)	RXD (from TXD of control source)
8)	TXD (to RXD of control source)

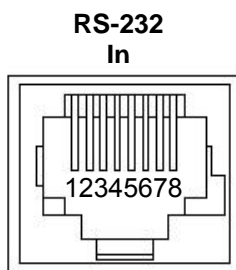

RS-232 Connector Out – Camera Shoe

#	Pins
1)	DSR (Sony Daisy chain from DTR)
2)	DTR (Sony Daisy chain to DSR)
3)	RTS (Canon Daisy chain from CTS)
4)	CTS (Canon Daisy chain to RTS)
5)	Unused
6)	Digital GND
7)	TXD (to RXD of control source)
8)	RXD (from TXD of control source)

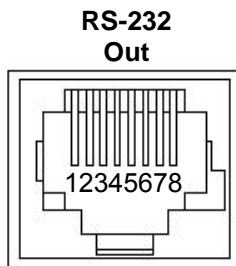

Power/Video Connection – RJ-45 – Quick-Connect Box

#	Pins
1)	Power +
2)	Power GND
3)	Video GND
4)	Y (luminance)
5)	Video GND
6)	C (Chrominance)
7)	Video GND
8)	Composite Video

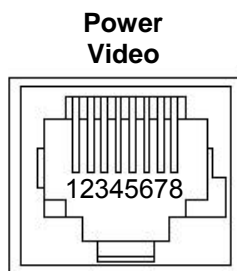



©2008 Vaddio - All Rights Reserved. Reproduction in whole or in part without written permission is prohibited. Specifications and pricing are subject to change without notice. Vaddio, WallVIEW, ControlVIEW, EZCamera, ProductionVIEW, Quick-Connect and PowerRite are registered trademarks of Vaddio. All other trademarks are property of their respective owners. Document Number 010-2201-000 Rev. F